

Design, Production and Analysis of Cylindrical, Coaxial and Alternating Current Shunts, using ANSYS

Igor Štambuk*, Jure Konjevod, Roman Malaric****

*Centre for Defense and Strategic Studies "Janko Bobetko", Croatian Defense Academy "Dr. Franjo Tuđman", Ministry of Defense of the Republic of Croatia, Ilica 256 b, 10000 Zagreb, Croatia, istambuk@morh.hr

**Department of Electrical Engineering Fundamentals and Measurements, Faculty of electrical engineering and computing, University of Zagreb, 10000 Zagreb, Croatia, jure.konjevod@fer.hr, roman.malaric@fer.hr

Abstract: This paper describes a new approach for designing with the ANSYS program, including cylindrical, coaxial and alternating current shunts, designed for currents from 10 A to 100 A, which are used as new work standards of the National Research Council (NRC), in the frequency range up to 100 kHz. The heating factor, is one of the more important issues, when determining the dimensions, i.e., the maximum current for which the shunt is intended. Using the ANSYS software package, a model for the current shunt is designed and the distribution of the temperature flux, of the coaxial shunt is analyzed. Further, the main stages of the 3D modeling of the temperature field are considered. The theoretical temperatures of the cylindrical shunt obtained by simulation, are compared with the experimentally determined temperature values, of the resistive shunt, of the same dimensions and characteristics, as carried-out in the laboratory, using the same currents.

Keywords: resistive coaxial shunt; ANSYS; 3D modeling; electrical power; metrology; resistive current transducer

1 Introduction

Today, due to the global energy crisis, power measurement is gaining more and more importance. The measurement of voltage and current magnitudes, provide a direct way of controlling the electric voltage and current in a circuit and the measurement of electric current can be achieved directly, by observing the effects of the current itself, or through the voltage drop across a well-defined impedance, which is considered a more stable and convenient method.

Current shunts, as one of the most common devices for measuring current, work as a passive device. Due to their excellent performance from DC level and up to high frequencies, even to 1 MHz, they are usually designed for the needs of AC electrical circuits [1] [2]. The main characteristics of current shunts are long-term stability, temperature and power coefficients (TCR and PCR), AC-DC difference and phase angle [3]. To create a functional high-current and high-frequency shunt, it is important to minimize phase error. The phase angle measurement error of current shunts is elaborated in [4]. The construction of the shunt can be performed using different techniques and methods, for example in the form of a foil and/or coaxial shunt, and the most common is the cage type. Such cage coaxial shunts are usually thoroughly characterized as presented in [5] and [6] respectively. Measurement setup and measurement method for AC-DC difference determination of the cage current shunts is presented in [7] and [8] respectively. However, in recent years the need for foil shunts has reemerged due to their exceptional conductivity at high frequencies. Design and fabrication of foil shunts in BEV, Austria with preliminary experimental results is presented in [9] while AC-DC difference of BEV foil shunts is presented in [10].

In the previous work, the emphasis was on measurement precision [11], designing a system for precise measurement of resistance etalons [11], and making elements that can supply the measuring system with a sufficient amount of stable current [12]. Significant improvements in NRC AC-DC differential current transfer measurement capability [2], intended mainly for applications in the frequency range from 10 Hz to 100 kHz, have been presented. The first step in the construction of the new foil shunt 100 A, 100 kHz [13] was also presented, and the parameters of the foil construction were defined, and based on the analysis and the obtained results, a method of determining the dimensions was developed. Thus, a newly designed shunt is proposed.

Different techniques and models are used in today's endeavors to have as accurate predictions as possible such as described in [14-17]. The ANSYS simulation system was also used in many tests [18-21] of structural durability, electrical and thermal properties, but with the development of application software, the ANSYS system offers us some new possibilities that are described in this paper. First of all, these are the possibilities of testing in the simulation before the shunt is produced and determining the behavior of the shunt when high alternating currents flow through it.

This paper presents the modeling of the shunt used in measuring systems with alternating current by the simulation system ANSYS [22]. Algorithms are explained gradually in chapter number two, through the presentation of individual stages of model development, from modeling in the SpaceClaim application (which is an integral part of the ANSYS program), through the process of defining the resolution and details of the analysis itself (Accurate Meshing), to building the model. After entering the Thermal electric model, and defining Steady-State Electric Conductions, where the voltage, current or heat that we supply to the model is

defined, along with the temperature of the environment in which the analysis will take place. In the third chapter, the results of analyzes that can be performed with the existing designed model are presented, so the electric field on the input side of the shunt and Total heat flow on the surface of the model are presented.

In order to analyze the results obtained with the simulation system ANSYS, [21] an AC shunt was created. The shunt is gradually heated over a period of ten minutes, and the temperature on the shunt surface is compared with the experimentally obtained data from ANSYS, in which the same heating conditions are simulated. The obtained data are connected, analyzed and given in the form of a conclusion.

2 Current Coaxial Shunt Design

In order to choose the appropriate simulation program, we tested several versions of the ANSYS Simulation & Design applications. We are looking for a model that in a relatively short time can show those parameters in the process of testing the characteristics of current shunts that would take a lot of time, i.e., it would be necessary to create a physical model of the current shunt and feed it with alternating current from a generator, and measure the processes mostly with expensive equipment in the laboratory. The capabilities of the tested simulation systems vary both in the area of design and in the area of calculation of the required display sizes and resolutions. One such designed shunt model developed in ANSYS version 17.0 is shown in Figure 1.

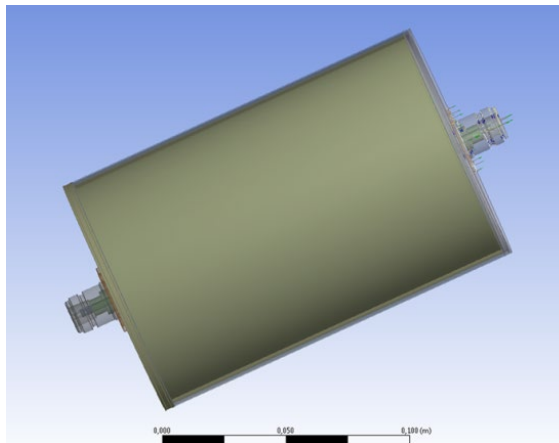

Figure 1

Shunt model created in the ANSYS 17.0 program

2.1. Modeling in the SpaceClaim Application

The final program selection was ANSYS version 2019. After defining the dimensions of the shunt, we started creating the model. Modeling is done in ANSYS SpaceClaim, which contains tools to speed up geometry preparation for modeling with 3D responses but is faster than complex traditional CAD systems. Geometry preparation is quite fast, as is shunt parameter entry, thanks to development tools to accelerate geometry preparation, which achieves a faster transition to simulation while eliminating delays between design teams.

Compared to modeling in ANSYS version 17.0, where individual parts of the assembly are added separately, SpaceClaim offers easy 3D modeling and provides tools for speeding up geometry preparation and creating much more complex 3D shapes in one part, as well as quick repairs of the model itself. Models created in the SpaceClaim application are compatible and customized with ANSYS version 19.0.

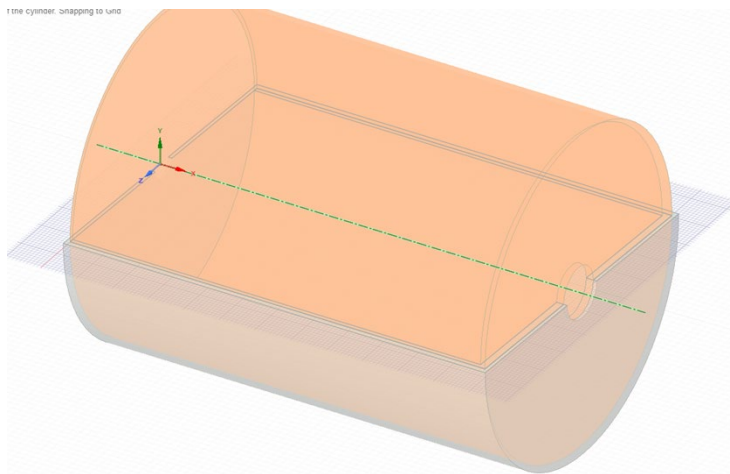

Figure 2

Designing a shunt in the ANSYS SpaceClaim program

Figure 2 shows the process of designing a shunt in such a way that layers of copper and manganin are designed around the PVC core, first those in the current part of the circuit. Between them, a layer is designed that contains properties of the Kaplan tape that was used as insulation between the conductive layers of the shunt.

Thermophysical properties of the manganin material of interest are given in Table 1. [23] [24] Manganin is a trademarked name for an alloy of typically 84.2% copper, 12.1% manganese, and 3.7% nickel.

All assembly segments are assigned material and connection properties. The following materials were used in this work: PVC, copper, manganin and Kaplan tape. In the process of creating the model, we also used other simulation programs

and compared the design results. In some applications, we have noticed defects related to performances with tape thickness in the process of connecting individual parts of the module, i.e., the inability to follow the line (broken line) of the model.

Table 1
Manganin thermophysical properties

Electrical Resistivity at 20 °C	0.43 $\mu\Omega/m$
Thermal Conductivity at 20 °C	22 W/mK
Specific Heat at 20 °C	0.41 J/gK
Density at 20 °C	8.4 g/cm ³
Tensile Strength at 20 °C	390 MPa
Melting Point	960 °C

2.2. Efficient Solutions from Accurate Meshing

One of the essential segments of shunt design is the selection of resolution for Accurate Meshing. ANSYS provides automated software that produces a suitable mesh for accurate, efficient multi-physics solutions. In this case, due to extremely thin layers, systematic automatic meshing of a highly constructed mesh with the necessary resolution to correctly capture solution gradients is required for reliable results. However, care should be taken that too high a resolution, increasing the amount of data, does not lead to system congestion and prevents the simulation itself from working properly.

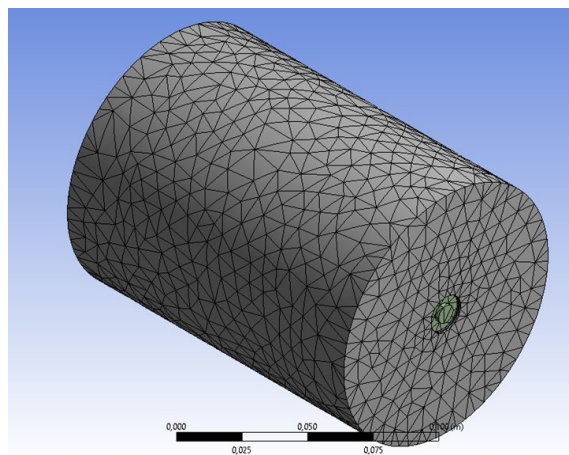

Figure 3

Choosing a resolution for Accurate Meshing

3 Measurement Results Analysis

In the process of building the model, after entering the Thermal electric model, we define Steady-State Electric Conductions, where we define the voltage, current or heat that we supply to the model, as well as the temperature of the environment in which the analysis will take place. Next, we define the information about the "Solution" that we want to get from the performed analysis, for example it is "Total electric field intensity, Total current density, Total heat flows, etc.). In the model, one can experiment with several input parameters, based on which is selected and which type of analysis is run for certain settings. As an example, analysis of the total electric field distribution and Total heat Flux are shown below.

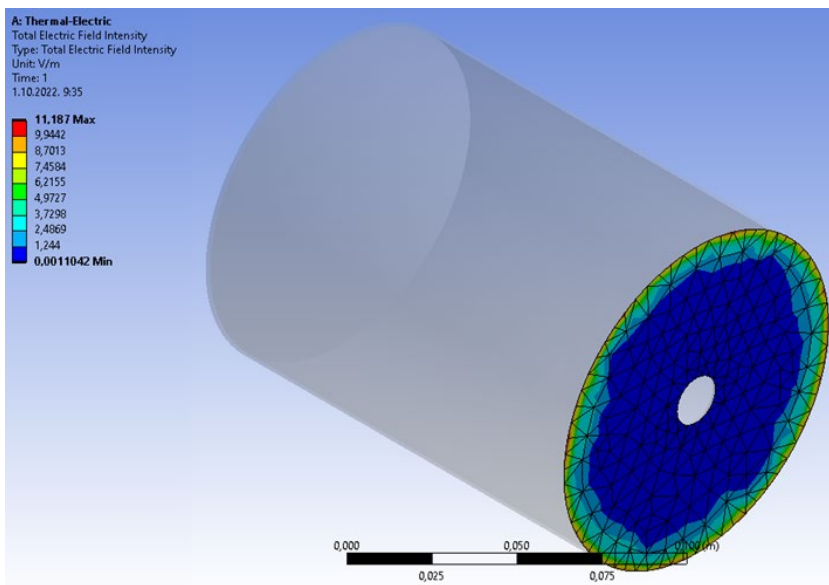

Figure 4

Distribution of the electric field on the input side of the shunt

Figure 4 shows the distribution of the electric field on the input side of the shunt, in the simulation program ANSYS, after applying a voltage of 10 V to the input of the shunt. It can be seen that the distribution of the electric field is strongest at the edges of the wall itself, which is expected due to the layer of manganin wrapped around the PVC core, which causes a stronger field with its resistance.

If we make an analysis in the "Thermal-Electric" area, Total heat Flux (W/m^2), it can be seen that the greatest heating is inside the shunt and in the part of the manganin, which due to its higher resistance heats up faster than other elements of the circuit.

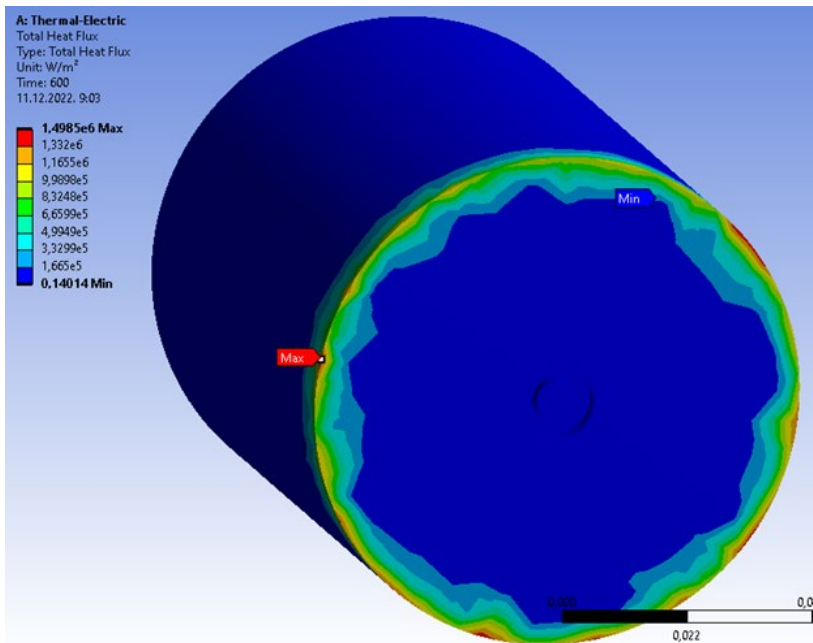

Figure 5

Total heat flow (W/m²) on the surface of the model

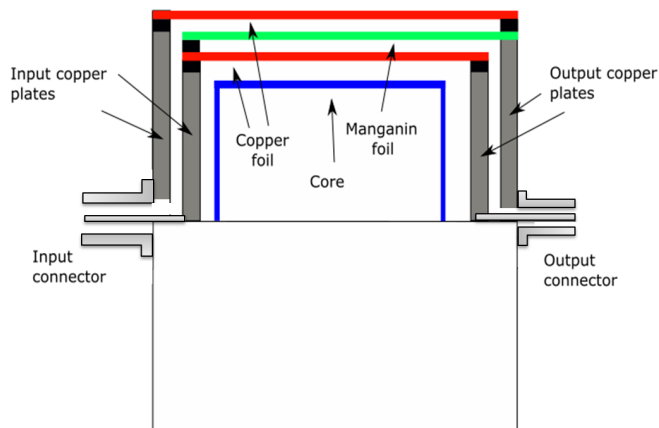

Figure 6

Simplified schematic of a tested cylindrical coaxial shunt

In order to compare the obtained results, we used a thermal image of a previously made and tested shunt. The tested resistive element is a cylinder made of thin manganin film with a thickness of 0.022 mm. Four circular copper plates, made of copper with a thickness of 5 mm, form parts of the input current and output voltage lines. The cylinder of the return current and the cylinder of the high-voltage line are

made of a thin copper foil with a thickness of 0.1 mm. Copper cylinders are located outside and inside the manganin cylinder. These three coaxial cylinders, molded on a glass fiber epoxy core, are mutually insulated and, if necessary, connected only at the inlet and outlet plates. The basic diagram of the shunt is shown in Figure 6.

3.1. Measurement of Resistance Shunt Heating in Laboratory Conditions

The measurement setup for resistance shunt heating in laboratory conditions determination is consisted of the function generator RIGOL DG4062, power amplifier TOELLNER TOE 7621 and tested current shunt. The function generator provides an input signal for the amplifier. Output of the applied amplifier is then connected to the input connector of the current shunt. The measurement scheme and the appearance of the tested shunt are shown in Figure 7.

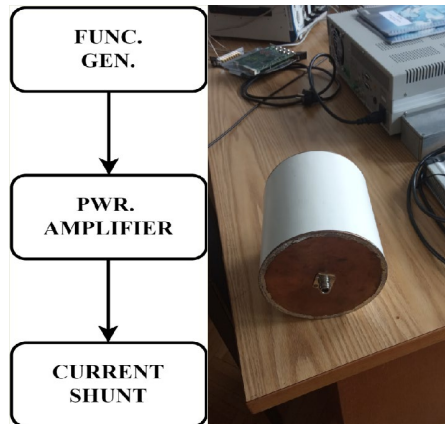

Figure 7

Measurement scheme and tested current shunt

Coaxial shunts were designed in such a way that each Vishay resistor is not loaded more than 30% of their power ratings. In such a way shunt will not be powered at maximum power ratings and will not overheat. Thus, for most practical applications, correction of measurement results due to self-heating, will not have to be performed, since the Vishay resistors have a low temperature coefficient. In the same way foil shunts will be operated at lower currents than possible even though Manganese foil has temperature coefficients in the range of several ppm/°C to avoid performing temperature coefficient corrections.

The main equation which is widely used for current measured with the current shunt is [25]:

$$I = \frac{U \cdot (1 + \delta_A + \delta_{sv} + \delta_{res} + \delta_{le})}{R_s \cdot (1 + \delta_{Rs} + \delta_{drift} + \delta_{ac-dc} + \delta_{tcr} + \delta_{pwc})} \quad (1)$$

, where U is measured ac voltage across the shunt, R_s is the DC resistance of the current shunt. Coefficients δ with related indexes in numerator represents corrections due to the repeatability of the ac voltage measurement, correction due to ac voltmeter deviation and due to the resolution of the AC voltmeter and correction due to the load effect on the reference AC voltmeter. Further corrections δ in denominator are due to the DC resistance measurement deviation, due to the drift, AC–DC difference, temperature and power coefficient of the shunt [25].

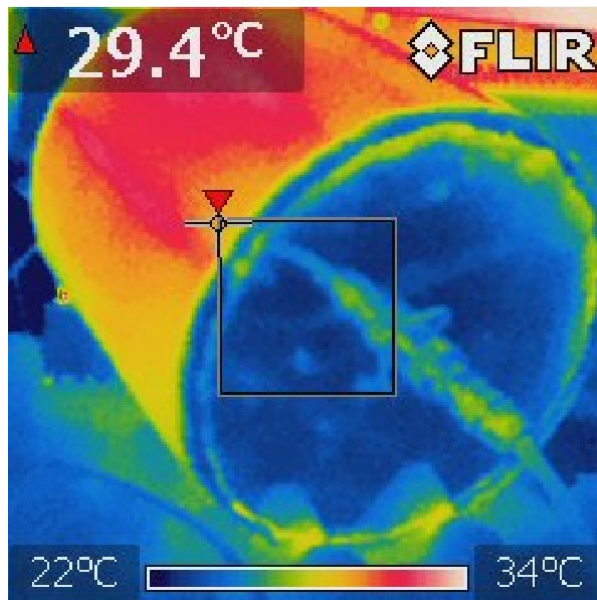

Figure 8

Image of shunt heating taken with FLIR thermal camera

An alternating current of 10A was connected to the shunt, and heating was monitored with a thermal FLIR camera. Fig 8 was created after 10 minutes of heating, and it clearly shows the degree of heating of individual parts of the shunt. The maximum temperature measured was on the formwork, that is, the outer layer of the resistive shunt, and it was 29.4 °C. The image shows a weaker heating of the side copper plates, due to their thickness, and a greater heating in the area of thin layers of conductive materials, more in the case of magnesium and less in the case of copper.

The disadvantage of this method of measuring with a thermal camera is the possibility of measuring temperature heating by layers separately, that is, from the image we only see the surface temperature, which in this case was caused by the heating of the layer below.

3.2. Simulation in the ANSYS Application and Analysis of the Results

In the simulation, we set identical parameters, the input alternating current of 10 A, and the time in which the results will be monitored of 10 min. The heating process itself can be viewed in a short video that the application offers. For the current, it is necessary to set it to be alternating with a frequency of 50 Hz. The adjustment is done in the "mechanical" settings, and on the magnitudes, you should click on the arrow to the right and select function.

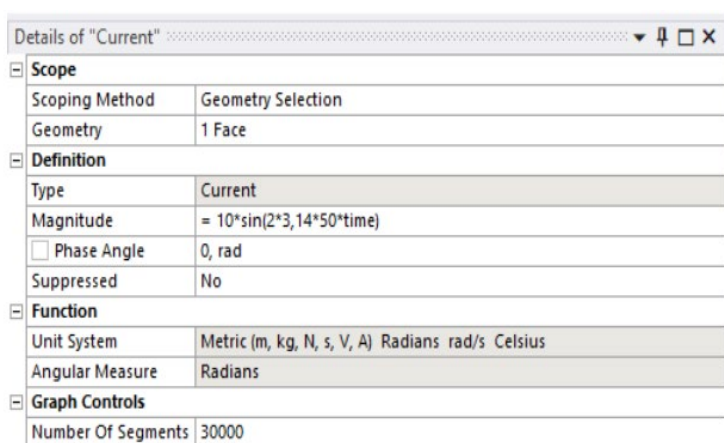

Figure 9

Settings for alternating current in the ANSYS application

If we compare the results, it is evident that the greatest heating is in the part of the manganin thin film, which has the greatest resistance and defines the total resistance of the shunt. It has been also seen that the mentioned heating penetrates through the surface of the shunt in the form of additional heating of the thin copper film located on the surface. The temperature that develops on the surface of the shunt in the case of measurement with a thermal camera is 29-31 °C, while in the case of simulation it is also 29.5-30.5 °C. The maximum temperature of the shunt was measured with a thermal camera at 34 °C, while in the simulation the maximum measured temperature was 32.5 °C. The maximum temperature develops on the inner layer of Manganin. Since the front entrance walls of the shunt are made of relatively thick copper plates, there was no significant increase in temperature during the observed period. The process of heating the shunt due to the flow of current can also be seen in video form in the ANSYS simulation.

It is also noticeable that the measurement with a thermal camera more vividly evokes thermal breakthroughs, in certain segments and creates a more realistic visual image of the processes taking place, while the simulation in the ANSYS application provides more detailed information for all of the processes and values achieved in the procedure.

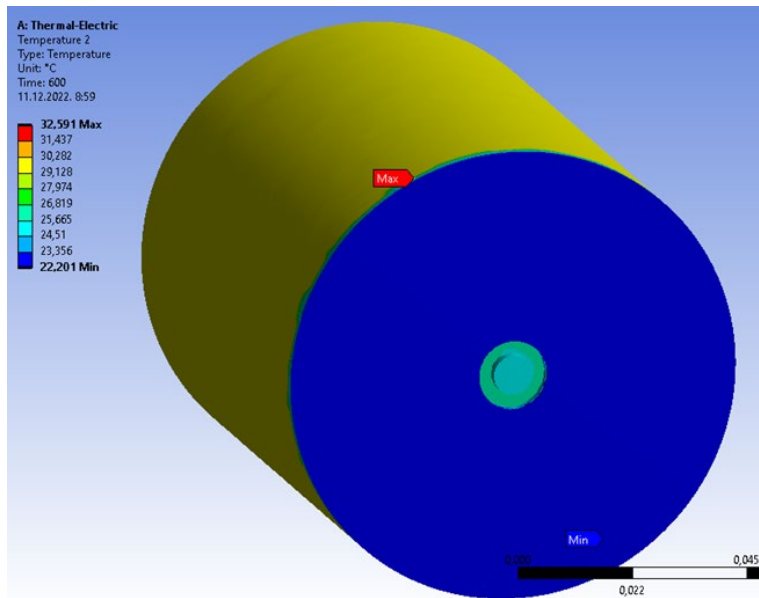

Figure 10

Temperature on the surface of the shunt after heating generated using the ANSYS application

Conclusions

Coaxial shunts are widely used, as part of electrical power control devices and power system testing equipment and for the precise measurements of alternating and direct currents, in wide dynamic and frequency ranges. This paper describes the design of the shunt, using a simulation program, as well as the results of the experimental performance and assessment of the influence of characteristics and dimensions, on the heating process, using the ANSYS software system. The analysis showed that the modeling of the thermal field and the calculated values of the heating temperature, of the shunt prototype, correspond, to a certain extent, to the values measured by the thermal camera. This research will make it possible to determine critical operating modes and identify the highest possible impulse current that will not lead to the destruction of the shunt.

References

- [1] J. Webster: Current shunts in Wiley Encyclopedia of Electrical and Electronics Engineering, John Wiley and Sons, Inc, 1999
- [2] C. Maxwell: A Treatise on Electricity and Magnetism, 3rd ed., Vol. 2, Oxford: Clarendon, 1892, pp. 68-73
- [3] J. Konjevod, R. Malarić, M. Dadić, P. Mostarac and H. Hegeduš: Measurement of DC properties and relative humidity (RH) dependence of wideband AC current shunts, Elsevier Measurement 131 (2019) 1-6, 2019

-
- [4] I. Budovsky: Measurement of phase angle errors of precision current shunts in the frequency range from 40 Hz to 200 kHz, *IEEE Trans. Instr. Meas.* 56 (2007) pp. 284-288
- [5] G. Rietveld, J. H. N. van der Beek, E. Houtzager, DC characterization of AC current shunts for wideband power applications, *IEEE Trans. Instr. Meas.* 60 (2011) pp. 2191-2194
- [6] B. Voljč, M. Lindič, B. Pinter, M. Kokalj, Z. Svetik, and R. Lapuh: Evaluation of a 100 A current shunt for the direct measurement of ac current, *IEEE Transactions on Instrumentation and Measurement*, Vol. 62, No. 6, 2013, pp. 1675-1680
- [7] V. Novakova Zachovalova: AC-DC current transfer difference in cmi, *Conference on Precision Electromagnetic Measurements (CPEM) 2008*, pp. 362-363
- [8] J. Konjevod, M. Dadić, R. Malarić, and I. Kunšt: Ac-dc transfer difference measurement of ac shunts, *Journal of Energy*, Vol. 67, No. 1, 2018
- [9] P. S. Filipškil, M. Boeckerl, M. Garcocz: 20-A to 100-A AC-DC Coaxial Current Shunts for 100 kHz Frequency Range, *Instrumentation and Measurement Technology Conference - IMTC 2007 Warsaw, Poland, May 1-3, 2007*
- [10] M. Garcocz, G. Heine Scheibenreiter, W. Waldmann: Progress on BEV foil shunts for AC-DC current transfer, *Precision Electromagnetic Measurements (CPEM 2014)*, Rio de Janeiro, Brazil, 2014, pp. 272-273
- [11] I. Štambuk; R. Malarić: Measurement system for precise comparison of low ohmic resistance standards, *Measurement*, 66 (2013) pp. 161-167, doi:10.1016/j.measurement.2015.02.011
- [12] I. Štambuk; R. Malarić: Development of 9 A current source for precise resistance measurement method, *Review of scientific instruments*, 83 (2012), 106105; 106105-1 doi:10.1063/1.4759022
- [13] P. Mostarac, T. Hrkač, R. Malarić, I. Kunšt: Development and frequency analysis of AC foil resistive current transducer – preliminary results, 3rd International Colloquium on Intelligent Grid Metrology (SMAGRIMET) online event, October 20-23, 2020
- [14] N. Ngoc Son, L. The Vinh: Parameter estimation of photovoltaic model, using balancing composite motion optimization, *Acta Polytechnica Hungarica*, Vol. 19, No. 11, pp. 27-46
- [15] E. Hedrea, R. Precup, R. Roman, E. M. Petriu: Tensor product-based model transformation approach to tower crane systems modeling, *Asian Journal of Control*, Vol. 23, No. 3, 2021, pp. 1313-1323

- [16] S. M. Abramov, S. Travin, G. Duca, R. Precup: New opportunities model for monitoring, analyzing and forecasting the official statistics on coronavirus disease pandemic (Rom. J. Inf. Sci. Technol. 26(1), 2023, pp. 49-64
- [17] I. Borlea, R. Precup, A. Borlea: Improvement of K-means cluster quality by post processing resulted clusters (Proc. Comput. Sci. 199, 2022, pp. 63-70
- [18] E. V. Bedareva, P. S. Marinushkin, and L. I. Khudonogova: Calculation of coaxial shunts superheat temperature, MTT'2014, 2014
- [19] M. El Khaldi, J. Bonis, A. Camara, L. Garolfi, A. Gonnin: Electromagnetic thermal, and structural analysis of Athomx RF gun using Ansys", Proceedings of IPAC2016, Busan, Korea, 2016
- [20] M. Venczel, M. Steidl, A. Veress: Design Modifications and Thermal Analysis of Visco-Dampers for Extending Silicone Oil Durability, Acta Polytechnica Hungarica Vol. 18, No. 8, 2021. pp. 27-46
- [21] H. Yıldız, E. Uzal, H. Çalık: An Analytical Solution of a Multi-Winding Coil Problem with a Magnetic Core in Spherical Coordinates, Acta Polytechnica Hungarica Vol. 18, No. 10, 2021, pp. 87-112
- [22] Ansys, ANSYS, Inc, <https://www.ansys.com>, 2023
- [23] Isabellenhuetten: Manganin® manufacturer's online datasheet, <https://www.spacematdb.com/spacemat/manudatasheets/MANGANIN-ISABELLENHUETTE-R.pdf>. Accessed 28 Dec, 2022
- [24] A. Schmon, K. Aziz, M. Luckabauer, G. Pottlacher: Thermophysical Properties of Manganin (Cu₈₆Mn₁₂Ni₂) in the Solid and Liquid State, International Journal of Thermophysics, Volume 36, 2015, pp. 1618-1626
- [25] B. Voljc, M. Lindic and R. Lapuh: Direct Measurement of AC Current by Measuring the Voltage Drop on the Coaxial Current Shunt, in IEEE Transactions on Instrumentation and Measurement, Vol. 58, No. 4, 2009, pp. 863-867, doi: 10.1109/TIM.2008.2007074